

WV 2 Plus D500

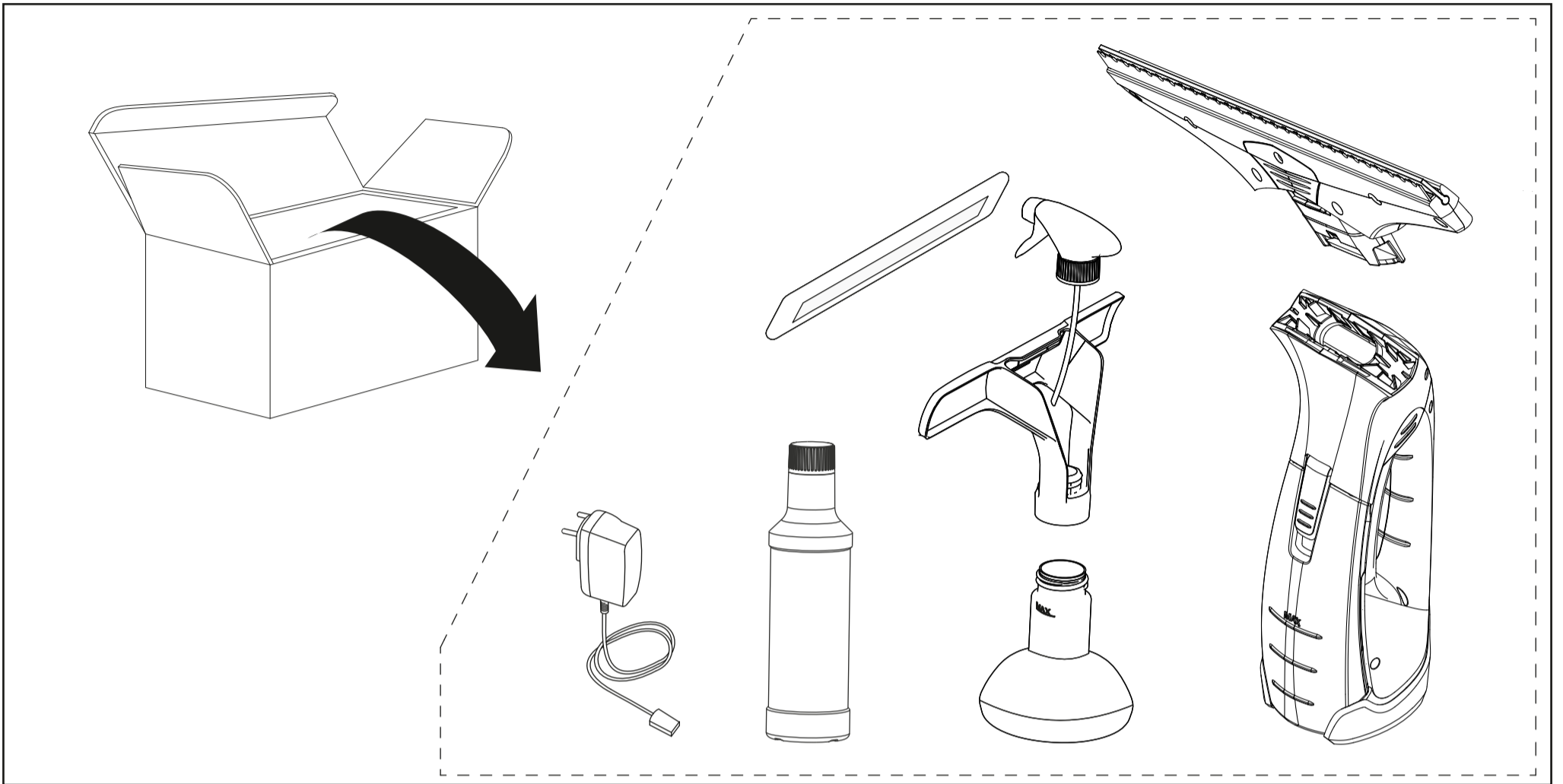

<p>Li-Ion</p>	<p>3,6 V</p> <p>3,7 V</p>		<p>IPX4</p>		<p>0,6 kg</p>
<p>nom</p>	<p>10 W</p>		<p>100 ml</p>		<p>230 min</p>
	<p>5,5 V</p> <p>600 mA</p>		<p>50 db(A)</p>		<p>35 min</p>

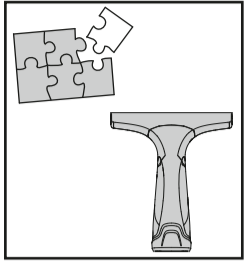
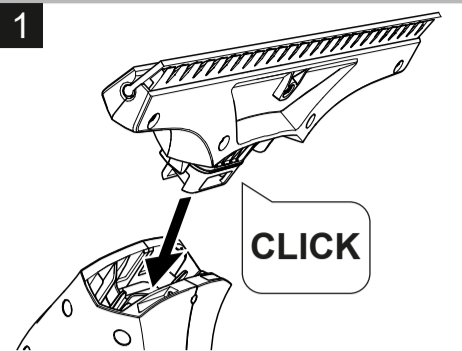

1  **CLICK**

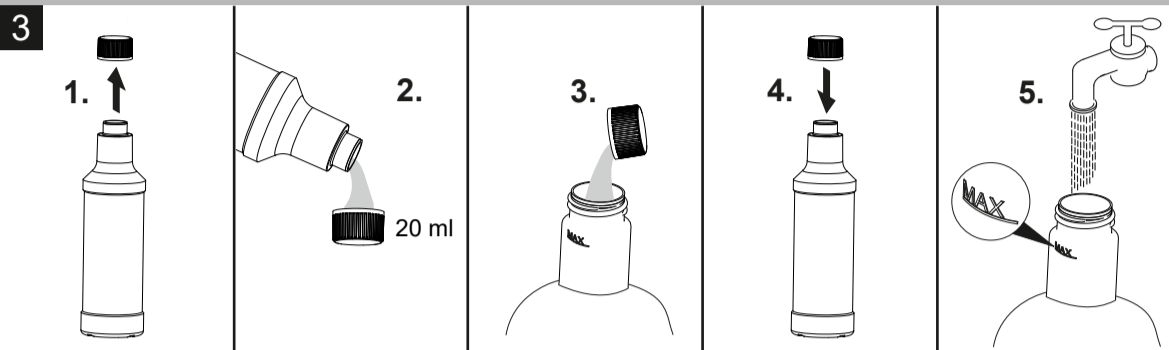
3  1. ↑ 2. 20 ml 3. 4. ↓ 5. MAX

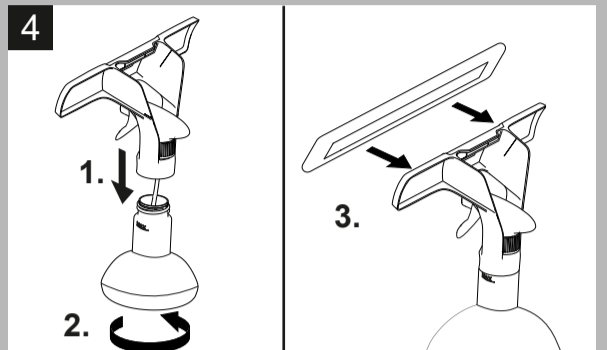
4  1. ↓ 2. ↻ 3.

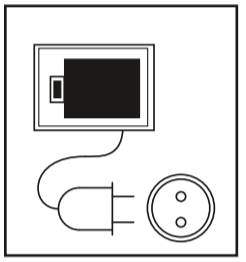

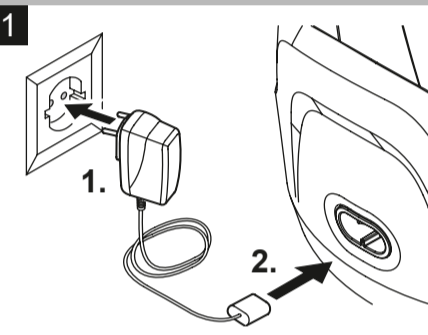
1  1. 2.

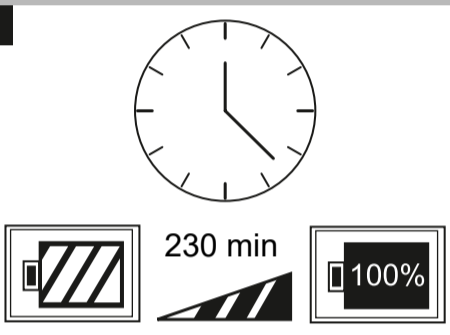
2  230 min 100% 60 min

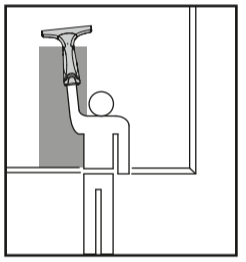

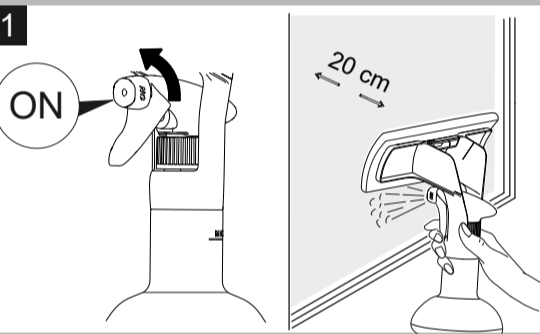
1  ON 20 cm

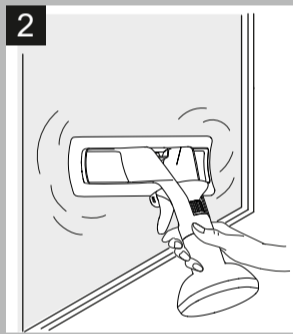
2 

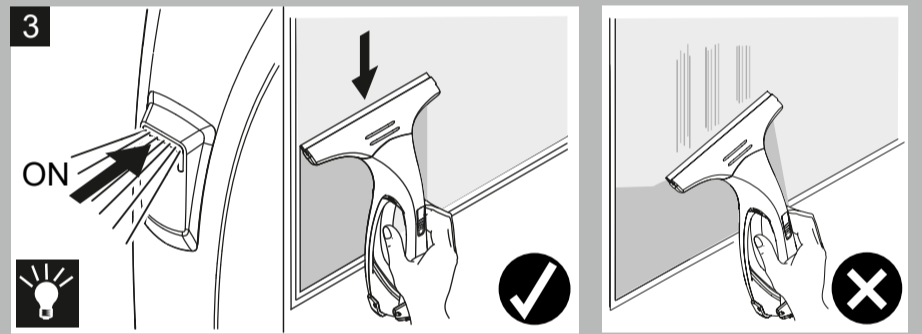
3  ON ✓ ✗

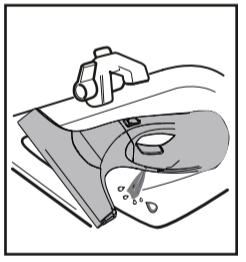

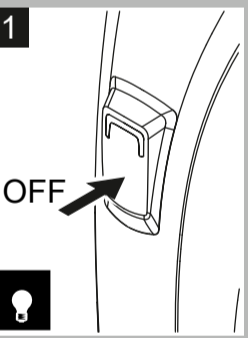
1  OFF

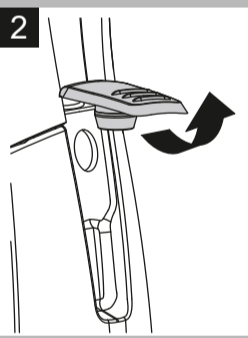
2 

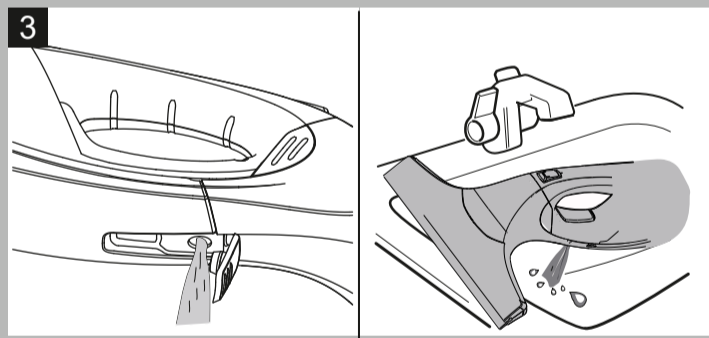
3 

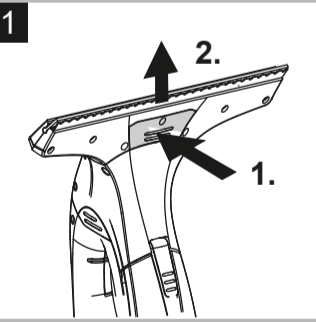

1  2. 1.

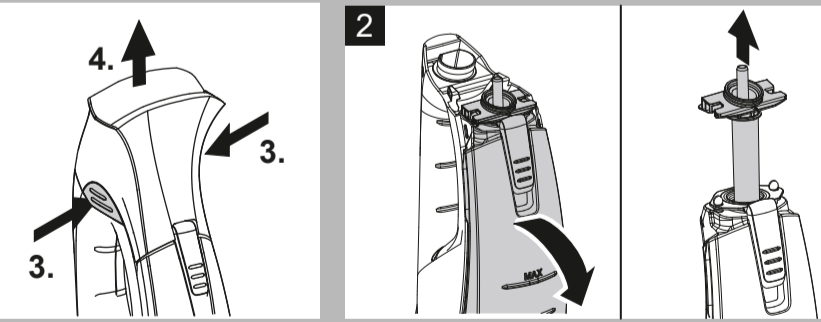
2  4. 3. 3.

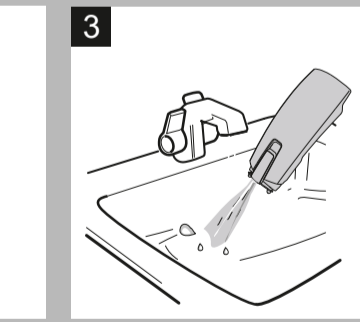
3 

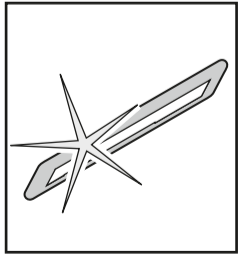

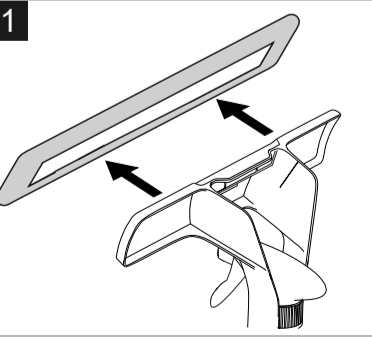
1 

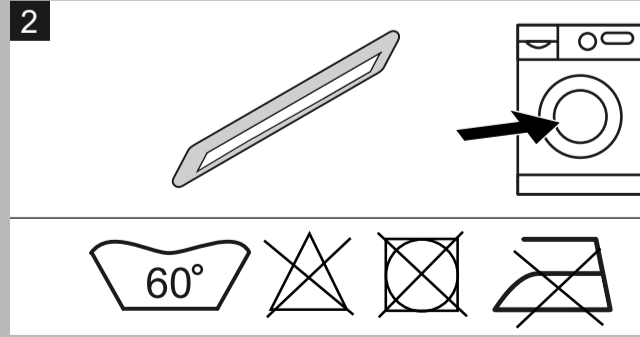
2  60°

